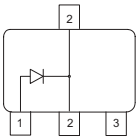
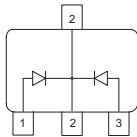

**Silicon Switching Diodes**

- Switching applications
- High breakdown voltage
- Pb-free (RoHS compliant) package <sup>1)</sup>
- Qualified according AEC Q101

**BAW78D**

**BAW79D**

Type	Package	Configuration	Marking
BAW78D	SOT89	single	GD
BAW79D	SOT89	common cathode	GH

**Maximum Ratings** at  $T_A = 25^\circ\text{C}$ , unless otherwise specified

Parameter	Symbol	Value	Unit
Diode reverse voltage	$V_R$	400	V
Peak reverse voltage	$V_{RM}$	400	
Forward current	$I_F$	1	A
Peak forward current	$I_{FM}$	1	
Peak forward current	$I_{FM}$	1	
Surge forward current, $t = 1 \mu\text{s}$	$I_{FS}$	10	
Non-repetitive peak surge forward current	$I_{FSM}$	-	
Total power dissipation	$P_{tot}$		W
BAW78D, $T_S \leq 125^\circ\text{C}$		1	
BAW79D, $T_S \leq 115^\circ\text{C}$		1	
Junction temperature	$T_j$	150	$^\circ\text{C}$
Storage temperature	$T_{stg}$	-65 ... 150	

<sup>1)</sup>Pb-containing package may be available upon special request

**Thermal Resistance**

Parameter	Symbol	Value	Unit
Junction - soldering point <sup>1)</sup>	$R_{thJS}$		K/W
BAW78D		≤ 25	
BAW79D		≤ 35	

**Electrical Characteristics at  $T_A = 25^\circ\text{C}$ , unless otherwise specified**

Parameter	Symbol	Values			Unit
		min.	typ.	max.	

**DC Characteristics**

Breakdown voltage $I_{(BR)} = 100 \mu\text{A}$	$V_{(BR)}$	400	-	-	V
Reverse current $V_R = 400 \text{ V}$ $V_R = 400 \text{ V}, T_A = 150^\circ\text{C}$	$I_R$	-	-	1 50	$\mu\text{A}$
Forward voltage $I_F = 1 \text{ A}$ $I_F = 2 \text{ A}$	$V_F$	-	-	1.6 2	V

**AC Characteristics**

Diode capacitance $V_R = 0 \text{ V}, f = 1 \text{ MHz}$	$C_T$	-	10	-	pF
Reverse recovery time $I_F = 200\text{mA}, I_R = 200\text{mA}$ , measured at $I_R = 20\text{mA}$ $R_L = 100\Omega$	$t_{rr}$	-	1	-	$\mu\text{s}$

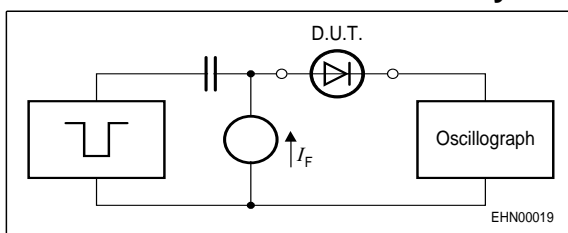
**Test circuit for reverse recovery time**

Puls generator:  $t_p = 10\mu\text{s}$ ,  $D = 0.05$ ,  
 $t_r = 0.6\text{ns}$ ,  $R_i = 50\Omega$

Oscilloscop:  $R = 50\Omega$ ,  $t_r = 0.35\text{ns}$   
 $C \leq 1\text{pF}$

<sup>1)</sup>For calculation of  $R_{thJA}$  please refer to Application Note Thermal Resistance

**Reverse current  $I_R = f(T_A)$**

$V_R = 400V$

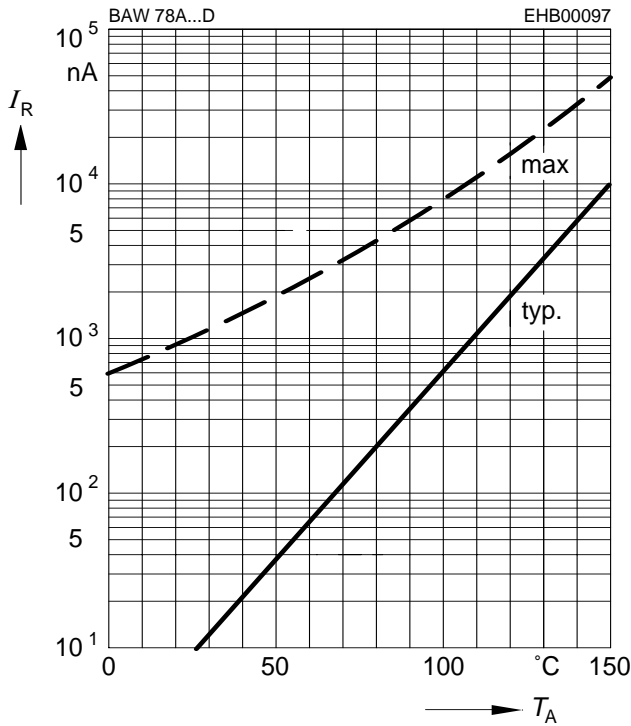

**Forward current  $I_F = f(V_F)$**

$T_A = 25^\circ C$

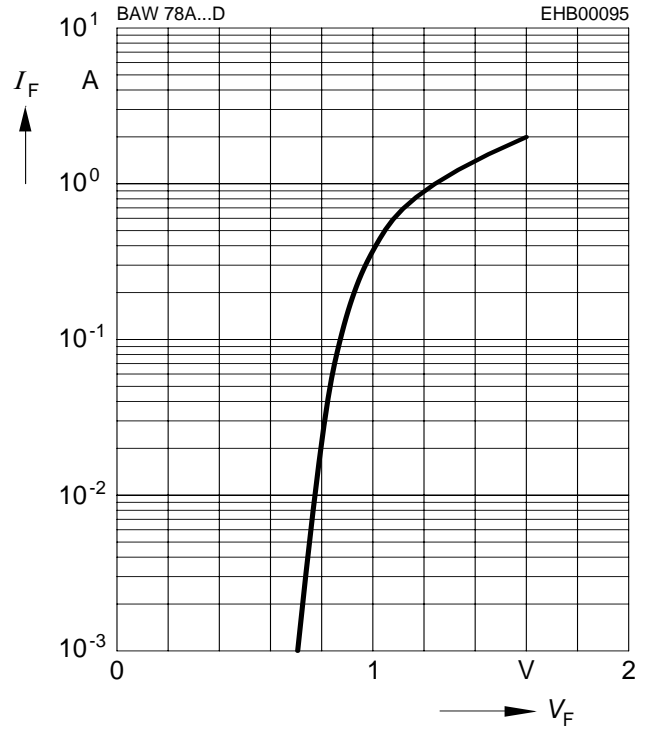

**Peak forward current  $I_{FM} = f(t_p)$**

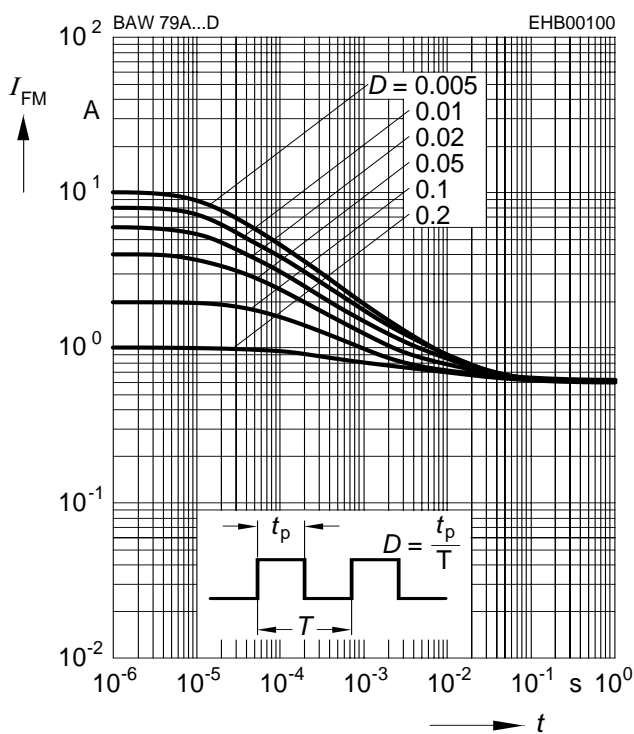

**Forward current  $I_F = f(T_S)$**

BAW78D

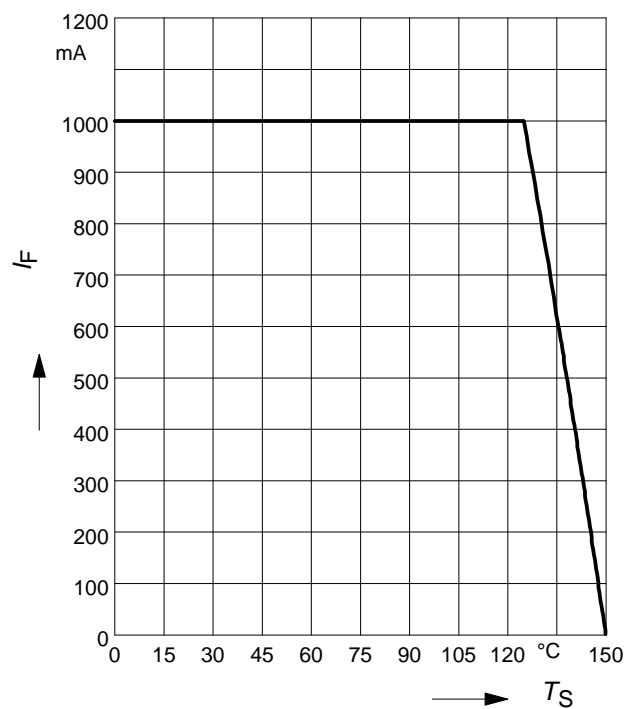

Forward current  $I_F = f(T_S)$

BAW79D

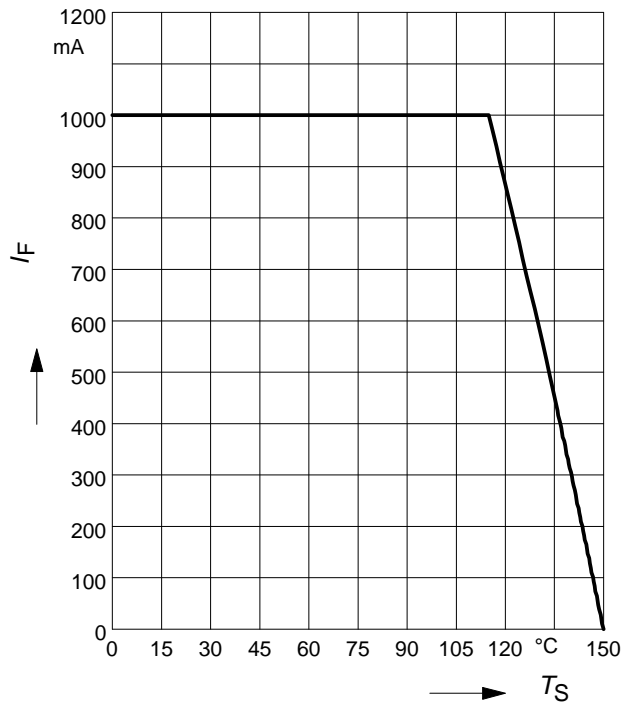

Package Outline

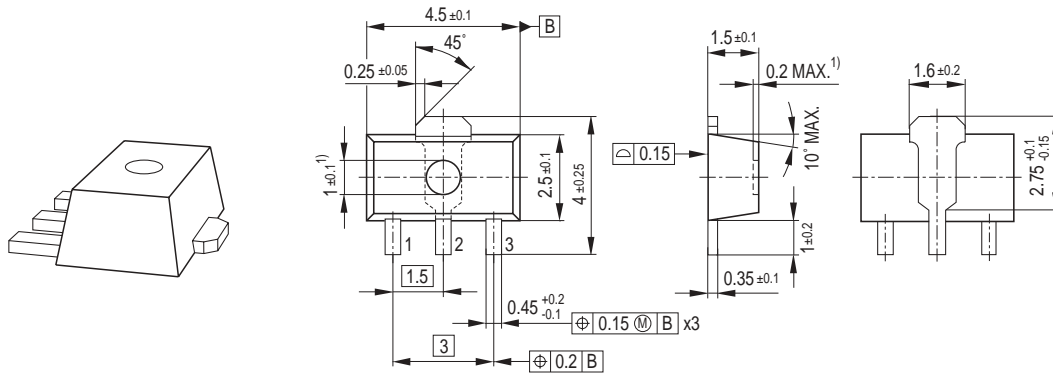

1) Ejector pin markings possible

Foot Print

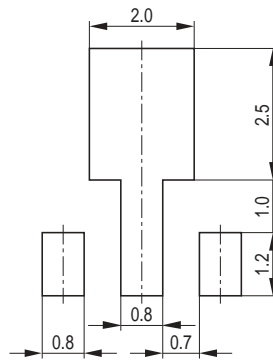

Marking Layout (Example)

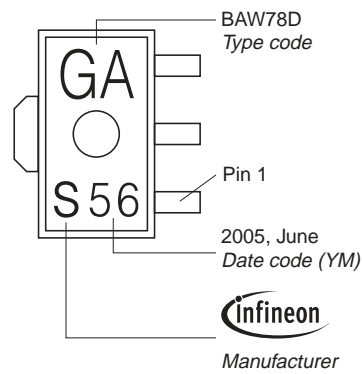

Standard Packing

Reel  $\varnothing 180$  mm = 1.000 Pieces/Reel  
 Reel  $\varnothing 330$  mm = 4.000 Pieces/Reel

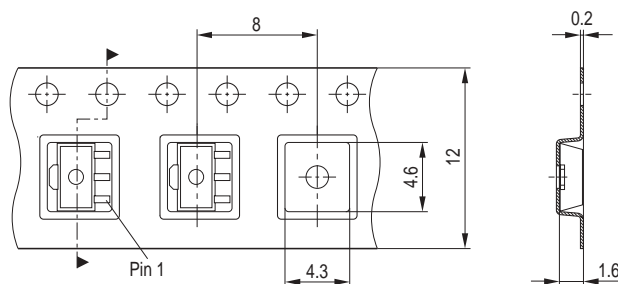

Edition 2006-02-01  
Published by  
Infineon Technologies AG  
81726 München, Germany  
© Infineon Technologies AG 2007.  
All Rights Reserved.

### **Attention please!**

The information given in this dokument shall in no event be regarded as a guarantee of conditions or characteristics ("Beschaffenheitsgarantie"). With respect to any examples or hints given herein, any typical values stated herein and/or any information regarding the application of the device, Infineon Technologies hereby disclaims any and all warranties and liabilities of any kind, including without limitation warranties of non-infringement of intellectual property rights of any third party.

### **Information**

For further information on technology, delivery terms and conditions and prices please contact your nearest Infineon Technologies Office ([www.infineon.com](http://www.infineon.com)).

### **Warnings**

Due to technical requirements components may contain dangerous substances. For information on the types in question please contact your nearest Infineon Technologies Office.

Infineon Technologies Components may only be used in life-support devices or systems with the express written approval of Infineon Technologies, if a failure of such components can reasonably be expected to cause the failure of that life-support device or system, or to affect the safety or effectiveness of that device or system.

Life support devices or systems are intended to be implanted in the human body, or to support and/or maintain and sustain and/or protect human life. If they fail, it is reasonable to assume that the health of the user or other persons may be endangered.